

# Barrier type terminal block

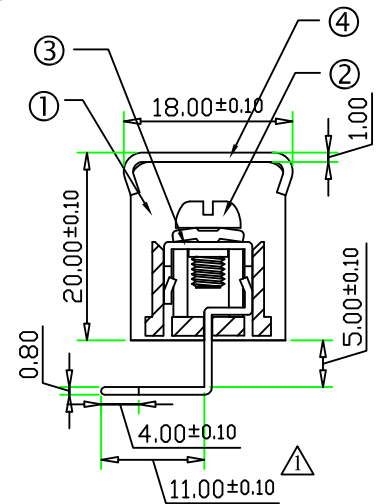
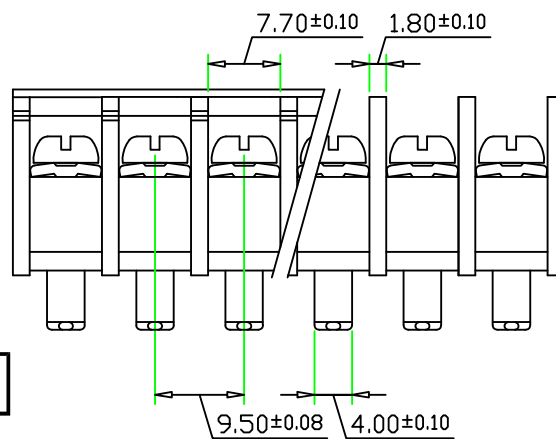
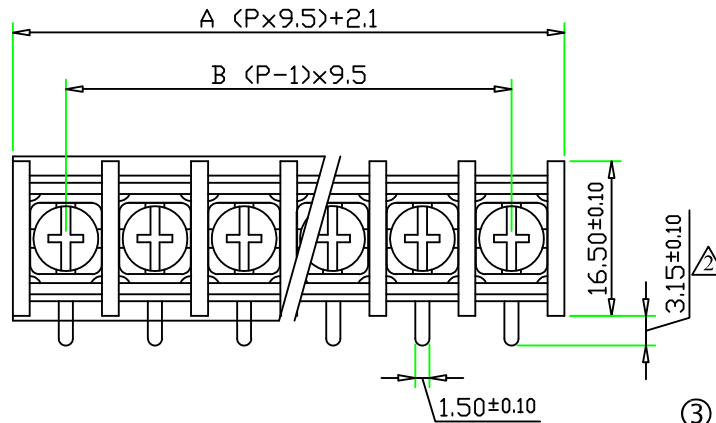
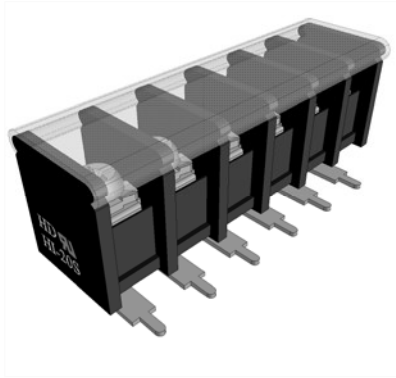

Part Number:

HI-203-P-

C: With Cover  
 Pole Size 2~32P

## SPECIFICATIONS

- ① Housing Material: Polyamide 66(UL94V-0), Black
- ② Screw: M3.5 Nickel Plated Steel
- ③ Terminals: Tin Plated Brass
- ④ Cover: PC Transparent

Screws Torque: 12 In-Lb

Wire Range: 14~22 AWG

Rated: 10 Amperes.AC250V

Operation Temperature:  $-55^{\circ}\text{C} \sim +95^{\circ}\text{C}$

Insulation withstands volt: AC2000V min

Insulation resistance:  $>1000\text{M}\Omega$  or more at DC500V